



—◆ **INSTALLATION
INSTRUCTIONS**

Check out our Installation Instruction Video using the QR code below:



TABLE OF CONTENTS

Additional Installation Instruction QR Codes	2
Care and Maintenance Note to Installers	3
Common Installation Mistakes	4
Corrugated Metal Deck Installation Instructions	5
ResinDek® Top Side Fasteners Installation Instructions	6
ESD Grounding Screw Installation Instructions	6
Invisi-Loc® Underside Fastening System Installation Instructions	7
ResinDek® with MetaGard® Installation Instructions	8

Additional Installation / Instruction QR Codes

View our additional ResinDek® installation instructions and guides for specific applications and needs. Simply scan each QR code below to be taken to the website where you can find the instructions / guides, helpful videos, and more.



ResinDek Over Steel Beams

ResinDek Xspan and Xspan FR installation instructions



ResinDek Over Bar Grate

ResinDek over bar grate installation instructions



ResinDek Over Wood Panels

ResinDek Max and more over wood installation instructions



ResinDek ReShield Over Wood

ResinDek ReShield over wood Installation Instructions



ResinDek Stand-Up Screw Gun

ResinDek stand-up screw gun quick start guide

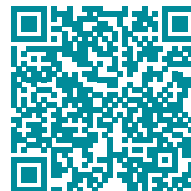

ResinDek Over Concrete

ResinDek HD over concrete Installation Instructions

Care and Maintenance

ResinDek® flooring provides long-lasting durability, but must be properly installed and maintained to avoid costly floor problems, repairs and hazards that may potentially void all product warranties. No matter the finish of your ResinDek flooring, the surface can be easily cleaned using a damp mop or standard cleaning solvents without fear of damaging the surface. Cleaning solutions that have worked particularly well include water, diluted isopropyl alcohol (3 to 1 mix), and many off the shelf detergents and floor cleaners. **NEVER USE METHYLENE CHLORIDE, DEGREASERS OR PAINT THINNERS WHICH WILL DAMAGE THE RESINDEK® FINISH. ALSO AVOID PROLONGED SOAKING, HOSING DOWN, OR WETTING OF ALL RESINDEK® PRODUCTS.** ResinDek® UF (unfinished) will clean up similar to other unfinished wood products.

Contact Cornerstone Specialty Wood Products, LLC® for a touch up kit if you need to repair minor scratches on ResinDek® floor panels, deep gouges, screw or bolt holes. All cracks and holes should be investigated since these are primarily due to loads in excess of ResinDek® recommendations. Excessive load damage to ResinDek® panels cannot always be repaired, and may need to be replaced.



Check out our Care and Maintenance Manual using the QR code.

Note to Installers

ResinDek is not intended for exterior applications. **RESINDEK PRODUCTS NOT INSTALLED IN ACCORDANCE WITH THE FOLLOWING INSTRUCTIONS WILL VOID ALL WARRANTIES.** ResinDek panels must be kept dry during transit and storage. Panels should be stored flat in a level position.

ResinDek should be installed over an approved corrugated metal deck or an existing mezzanine floor surface. Refer to page 4 to confirm metal deck is properly fastened down per approved installation instructions. Substructures must be capable of supporting the loads in the chart below. Failure of substructure may result in local failure of ResinDek. A minimum of 20 gauge steel is required when using corrugated metal B Deck or N Deck. 18 gauge is recommended for loads exceeding 2,500lbs (1134 kg).

CONFIRM THAT THE WEIGHT OF THE UNIT WILL NOT EXCEED THE CAPACITY OF THE PANEL PRIOR TO MOVING IT ACROSS A FINISHED RESINDEK FLOOR. THESE VALUES ARE BASED ON A STANDARD MANUAL PALLET JACK. SEE PAGE 8 FOR RESINDEK WITH METAGARD WEIGHT AND LOAD TABLE.

Product (B Deck Gauge)	Weight (psf) / (kg/m ²)	Pcs per Unit	Weight per Unit for 4'x6' (1.22m x 1.83m) panels (lbs) / (kg)	Weight per Unit for 4'x8' (1.22m x 2.44m) panels (lbs) / (kg)	Weight per Unit 4'x10' (1.22m x 3.05m) panels (lbs) / (kg)	Rated Pallet Jack Load Capacity (lbs) / (kg)
ResinDek® LD (20ga)	2.8 (13.7)	32	2,150 (976)	2,868 (1,301)	3,584 (1,626)	2,000 (907)
ResinDek® WR (20ga)	3.2 (15.6)	32	2,458 (1,115)	3,277 (1,487)	4,096 (1,858)	2,000 (907)
ResinDek® MD (18ga)	3.5 (16.6)	32	2,688 (1,222)	3,584 (1,629)	4,480 (2,036)	3,500 (1,588)
ResinDek® HD (18ga)	3.8 (18.6)	32	2,918 (1,329)	3,891 (1,772)	4,864 (2,215)	4,500 (2,041)
ResinDek® Xspan® & ResinDek® Xspan® FR (B-Deck N/A)	5.2 (25.4)	21	2,621 (1,191)	3,494 (1,588)	4,368 (1,985)	3,000 at 16" O.C. (1,360 at 406mm O.C.)

WARNING: UNDER CONDITIONS OF EXTREME HUMIDITY, RESINDEK® MAY BE PRONE TO LINEAR EXPANSION. ResinDek panels, like most other mezzanine floor panels in the industry, are prone to linear expansion. Because ResinDek panels are extremely dense and don't crush under load, they are particularly susceptible to buckling if the panels expand into adjacent panel edges. Once maximum growth is achieved, the gaps rarely shrink and remain quite stable. We manufacture the panels 1/8" under nominal dimensions to allow for gapping. When spaced properly, a nominal 4'x8' (1.22m x 2.44m) panel will take up exactly 48" x 96" (1.22m x 2.44m) of floor space.



Common Installation Mistakes That Can Void Your 10-Year Warranty

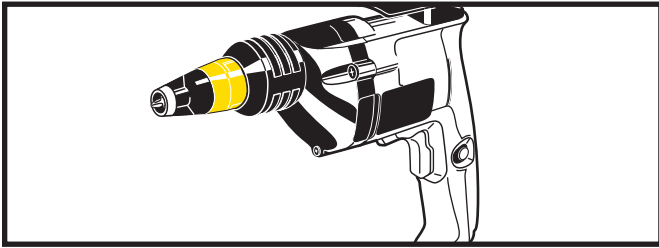

Must use screw driver/gun with operable clutch for consistent screw depth setting. For best results use stand-up screw gun.

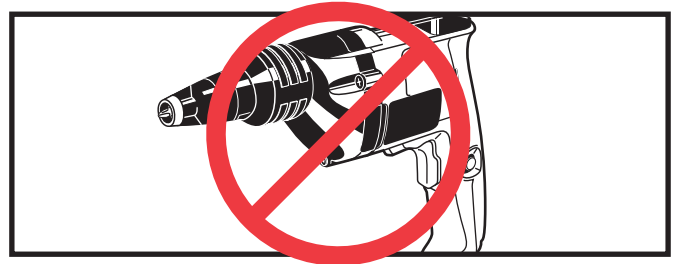

Do not use screw driver/gun with no clutch or a broken clutch.

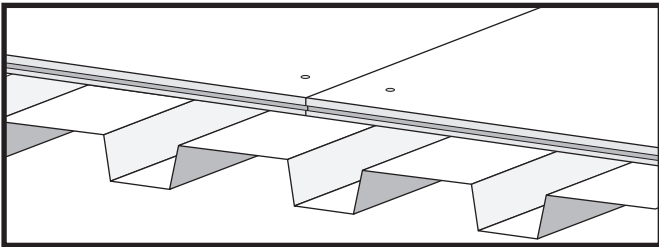

Panels must meet on high points (ribs) of corrugated deck

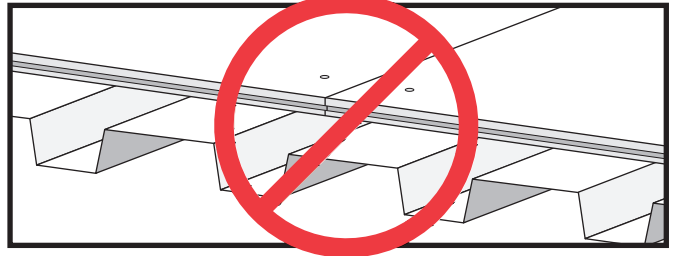

Do not place panel edges on top of corrugated deck low points (valley).

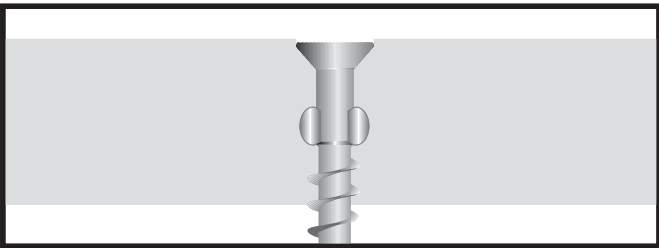

Approved screws must be placed just below the panel surface.

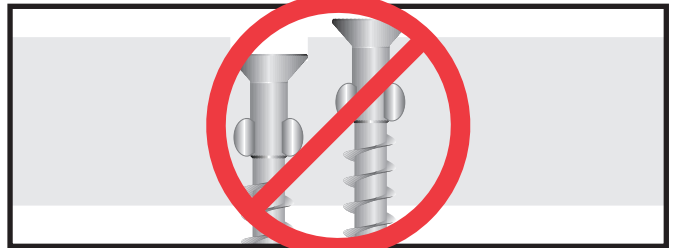

Do not place approved screws too high or too low in the panels.

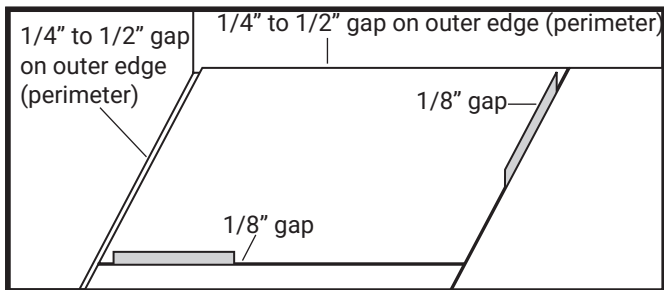

Use 1/8" (3mm) spacer between panels for correct spacing. The gap on the outer edge (perimeter) must not be less than a 1/4" (6mm) or exceed a 1/2" (12mm). See page 8 for ResinDek with MetaGard gapping recommendation.

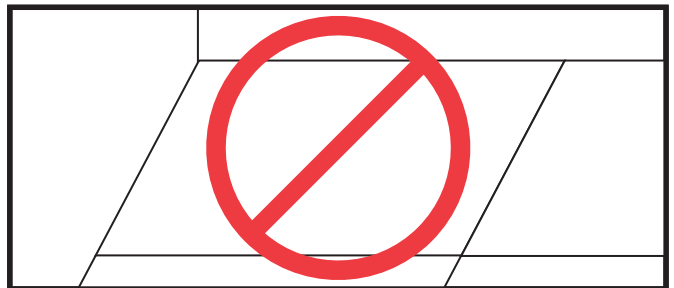

Do not install panels without an 1/8" (3mm) gap between panels and a minimum of a 1/4" (6mm) to a maximum 1/2" (12mm) gap on the outer edge (perimeter) of the panels.

FAILURE TO INSTALL RESINDEK® AS INSTRUCTED WILL VOID ALL WARRANTIES.

Installation Instructions - Corrugated Decking

If corrugated deck instructions or drawings were not provided, please refer to the American National Standard/Institute Steel Deck RD-2022 Standard for Steel Roof Deck - <https://sdi.org/publications/publications/misc-publications/ansi-sdi-sd-2022-standard-for-steel-deck/>

In addition to the document above, please consider the following when installing corrugated deck:

- Please ensure the correct side is up.
- Recommend using structural screws to properly secure the metal deck. Other types of SDI approved methods could lead to elevation issues, which can cause installation difficulty and potential failures when used with wheel loads.
- When overlapping in the width direction, ensure panel spacing remains consistent (for example B-Deck rib should be on 6" (152mm) centers). Failure to do so could result in an increase need for valley shims, cutting of panels, or elevation issues.
- During layout do not over crowd panels; it is best to install and secure the panels one at a time.
- The corrugated metal deck should be installed with a levelness tolerance of +/- 1/8" (3mm) over a 24" (610mm) distance.
- Once installed we recommend that you remove debris and excess fasteners prior to installing the ResinDek flooring panels.

Installation Instructions - ResinDek® Top Side Fasteners in Corrugated Metal Deck

NOTE: INSTRUCTIONS BELOW ARE FOR RESINDEK® PANELS WITH GRAY DIAMOND SEAL®ESD, TRIGARD® ESD, TRIGARD® ESD ULTRA AND UF (UNFINISHED) ONLY.

Begin your floor installation by reviewing all approved drawings and instructions. If drawings were provided, install per installation drawings. If drawings were not provided, stagger the floor panels in a brick pattern.

- Use a laser, transit, chalk line, or string to set a true line less than 48" (1219mm) from one edge of the mezzanine to align the long edge of the panel. This will allow you to trim panels for proper spacing around the perimeter.
- ResinDek panels can be laid parallel to the corrugated metal deck, perpendicular is the preferred direction.
- For flatness requirements on Robotic floors, please refer to robotic manufacturers specification. If none are provided, please default to +/- 1/8" (3mm) over 36" (914mm).
- Make sure the panels are installed with the correct surface on top. Located on the edge of each ResinDek panel is a stamped part number. When correctly installed, the stamp will be right side up.
- To avoid weak joints that may damage your floor, take caution to lay the panels down with the joints over the ribs whenever possible (**Figure A**). Panels must be cut back, or placed on top of a minimum 6" (152mm) wide, 20-gauge valley shim, when ResinDek panels break on a valley (**Figure B**). These valley shims can be obtained from Cornerstone Specialty Wood Products, LLC®. Do not use wood blocks in the valley of the decking, as they may cause the panel joints to become uneven. **PLACING RESINDEK PANEL JOINTS ON VALLEYS WITHOUT PROPER VALLEY SHIMS WILL VOID YOUR WARRANTY.**
- ResinDek panels are a wood based product and may expand over time. Therefore, you must leave an 1/8" (3mm) minimum gap between ResinDek panels. The gap on the outer edge (perimeter) must not be less than a 1/4" (6mm) or exceed a maximum of a 1/2" (12mm) (**Figure C**).
- Attached to each ResinDek bundle is a package that includes installation instructions and three 1/8" (3mm) thick metal panel spacers. Between all adjacent panels insert the metal spacers, two along the long edge and one along a short edge, to ensure proper gapping between the panels. **FAILURE TO USE METAL PANEL SPACERS MAY ALLOW FLOOR TO BUCKLE AND WILL VOID ALL WARRANTIES**
- It is essential to trim the last row of panels to allow for a 1/4" (6mm) to a 1/2" (12mm) gap along the outer edges of the ResinDek floor perimeter. You can trim ResinDek panels to size with a circular saw. Carbide tip blades are recommended for best results.

Figure A.

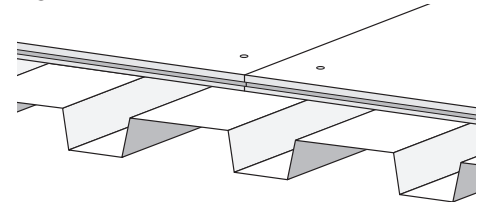

Figure B.

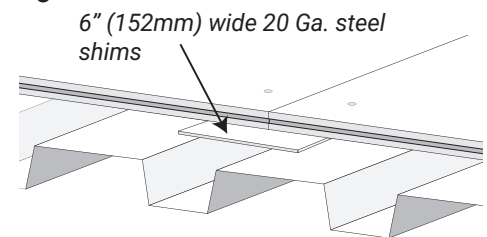
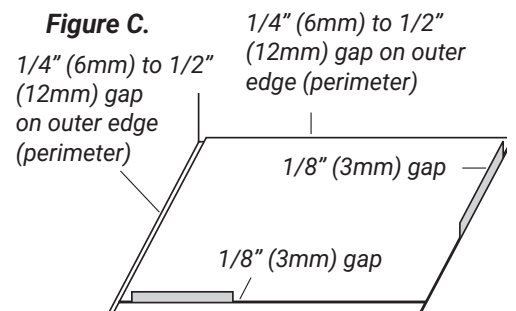

Figure C.



Installation Instructions - ResinDek® Top Side Fasteners in Corrugated Metal Deck (cont.)

- Attach ResinDek panels to the corrugated metal deck using a minimum of 0.625 screws per 1 sqft which equals 20 screws per 4'x8' (1219mm x 2438 mm) sheet (**Figure D**). If your panel has an ESD based coating, a minimum of four grounding screws will be required per 4'x8' (1219mm x 2438 mm) panel, which will count towards the minimum screw requirement. Refer to the ESD Grounding Screw installation instructions found below or watch the ESD Grounding Screws installation video for more information.
- Screws must penetrate both the ResinDek panel and the corrugated metal deck. **FAILURE TO USE APPROVED SCREWS MAY VOID ALL WARRANTIES ON RESINDEK FLOOR PANELS.** For best results always use ResinDek screws furnished by Cornerstone Specialty Wood Products, LLC®.
- Use a white chalk line (for ease of cleaning) to mark a grid for locating the screws, making sure to locate all screws a minimum of 1" (25mm) from panel edges.
- Secure each panel with a minimum of two screws before installing the next panel and removing the panel spacers. When fastening panels use only a screwdriver with a clutch or depth limiter to properly counter sink screw heads. Cornerstone Specialty Wood Products recommends and sells a 2500 RPM Senco® Stand-up Screwdriver. Please refer to our website for more information.
- Drive screws so that the top is just below the panel surface (**Figure E**). Proper screw head depth is critical to performance and appearance of your ResinDek floor. Use caution, as backing out or removing improperly installed screws may damage the panel.

Figure D.

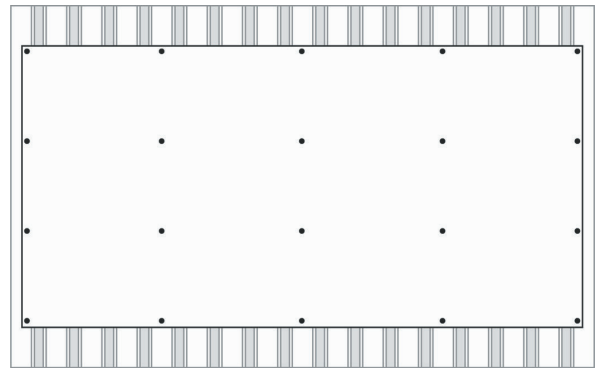
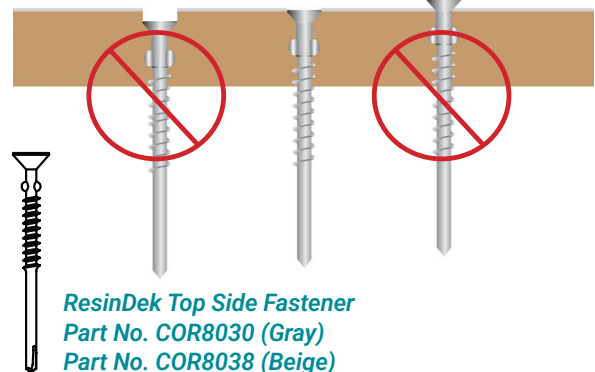

Figure E.



Installation Instructions - ResinDek® ESD Grounding Screws

For proper grounding performance of ResinDek Gray Diamond Seal® ESD, TriGard® ESD and TriGard® ESD Ultra panels install four (4) grounding screws on any panel that is 4'x8' (1219mm x 2438 mm) or less. Larger panels will require additional grounding screws. Examples of grounding screw installation patterns can be seen below (**Figure F**). Distance to the closest screw must not exceed 4' (1219mm), regardless of panel size. **PROPERLY INSTALLED GROUNDING SCREWS ARE NECESSARY FOR A FULLY COMPLIANT ESD FLOOR.**

The underside of the grounding screw head must be installed flush with the top surface of the panel. Be careful to not strip out screws from the corrugated decking.

ResinDek panels attached to the corrugated metal deck requires a minimum of 0.625 screws per 1 sqft (0.093 m²) which equals 20 screws per 4'x8' (1219mm x 2438 mm) sheet. For panels that have ResinDek Gray Diamond Seal ESD, TriGard ESD or TriGard ESD Ultra coating, the grounding screws will count towards the minimum requirement of fasteners.



ResinDek ESD
Grounding Screw
Part No. COR8005



ResinDek ESD
Grounding Screw
Part No. COR8070
For TriGard ESD and Tri-
Gard ESD Ultra only.

Figure F - ESD Screw Installation
Cross Section - Screws must be flush with deck surface!

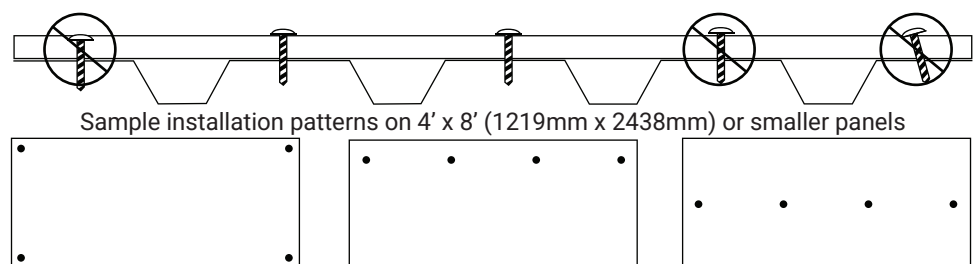

Installation Instructions -

ResinDek® *Invisi-Loc* Underside Fastening System

Begin your floor installation by reviewing all approved drawings and instructions. If drawings were provided, install per installation drawings. If drawings were not provided, stagger the floor panels in a brick pattern.

- If corrugated metal deck has been pre-punched, skip to the next step. Otherwise, drill 17/64" (6.8mm) holes in the corrugated deck using Figure A as a template. Holes should be drilled in a 6" (152mm) grid pattern.
- Use a laser, transit, chalk line, or string to set a true line less than 48" (1.22mm) from one edge of the mezzanine to align the long edge of the panel. This will allow you to trim panels for proper spacing around the perimeter.
- ResinDek panels can be laid parallel to the corrugated metal deck, perpendicular is the preferred direction.
- Make sure the panels are installed with the correct surface on top. Located on the edge of each ResinDek panel is a stamped part number. When correctly installed, the stamp will be right side up.
- With weight on the top of the panel, use a 17/64" (6.8mm) stopper bit to drill holes from the bottom through the corrugated and into the ResinDek panel. Underside fasteners should be installed into holes using an approved pneumatic tool. If one was not provided contact Cornerstone Specialty Wood Products, LLC®.
- Secure each panel with a minimum of four underside fasteners before installing the next panel. **INSTALL UNDERSIDE FASTENERS SO THAT THE HEAD IS TIGHT TO THE BOTTOM SIDE OF THE CORRUGATED DECK.**
- Attach panels to corrugated deck or other approved sub-flooring using a minimum of 20 underside fasteners per 4' x 8' (1219mm x 2438mm) sheet. (See **figure A**) For best results, use ResinDek® *Invisi-Loc*® underside fasteners furnished by Cornerstone Specialty Wood Products®.
- Fasteners should be located a minimum of 1" (25mm) from panel edge. Remove metal panel spacers and insert between next panels.
- ResinDek panels are a wood based product and may expand over time. Therefore, you must leave an 1/8" (3mm) minimum gap between ResinDek panels. The gap on the outer edge (perimeter) must not be less than a 1/4" (6mm) or exceed a maximum of a 1/2" (12mm) Attached to each ResinDek bundle is a package that includes installation instructions and three 1/8" (3mm) thick metal panel spacers. Between all adjacent panels insert the metal spacers, two along the long edge and one along a short edge, to ensure proper gapping between the panels. **FAILURE TO USE METAL PANEL SPACERS MAY ALLOW FLOOR TO BUCKLE AND WILL VOID ALL WARRANTIES.**
- It is essential to trim the last row of panels to allow for a 1/4" (6mm) to a 1/2" (12mm) gap along the outer edges of the ResinDek floor perimeter. You can trim ResinDek panels to size with a circular saw. Carbide tip blades are recommended for best results.
- To avoid weak joints that may damage your floor, take caution to lay the panels down with the joints over the ribs whenever possible. Panels must be cut back, or placed on top of a minimum 6" (152mm) wide, 20-gauge valley shim, when ResinDek panels break on a valley (**Figure B**). These valley shims can be obtained from Cornerstone Specialty Wood Products. Do not use wood blocks in the valley of the decking, as they may cause the panel joints to become uneven. **PLACING RESINDEK PANEL JOINTS WITHOUT PROPER VALLEY SHIMS WILL VOID YOUR WARRANTY.**
- **NOTE: GROUNDING SCREWS MUST BE USED WITH ANY RESINDEK ESD COATED PANELS (GRAY DIAMOND SEAL® ESD, TRIGARD® ESD OR TRIGARD® ESD ULTRA).**



Figure A - Corrugated Deck Grid Pattern for *Invisi-Loc*®

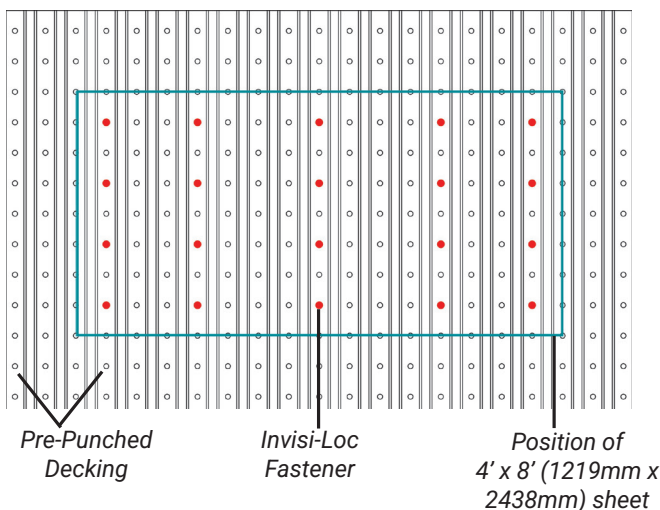
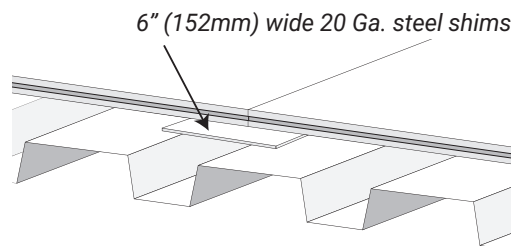

Figure B.



When ResinDek breaks on a valley use 6" (152mm) wide 20 Ga. min. steel shims. Avoid using wood blocks, which may cause panel joints to become uneven.

***Invisi-Loc* Fastener**



Part No. COR8040
for 1-1/8" (25mm)
Xspan
and
Part No. COR8028
for 3/4" (19mm) Panels

Installation Instructions - ResinDek® with MetaGard® *Top Side Fasteners* in Corrugated Metal Deck

CONFIRM THAT THE WEIGHT OF THE UNIT WILL NOT EXCEED THE CAPACITY OF THE PANEL PRIOR TO MOVING IT ACROSS A FINISHED RESINDEK FLOOR. THESE VALUES ARE BASED ON A STANDARD MANUAL PALLET JACK.

Product (B Deck Gauge)	Weight (psf) / (kg/m ²)	Pcs per Unit	Weight per Unit for 4'x8' (1.22m x 3.05m) panels (lbs) / (kg)	Rated Pallet Jack Load Capacity (lbs) / (kg)
ResinDek® LD MetaGard® (20ga)	4.2 (20.5)	24	3,226 (1,463)	2,000 (910)
ResinDek® MD MetaGard® (18ga)	4.9 (23.9)	24	3,763 (1,707)	3,500 (1,590)
ResinDek® HD MetaGard® (18ga)	5.2 (25.4)	24	3,994 (1,812)	4,500 (2,045)
ResinDek® Xspan® MetaGard® B Deck Not Required	6.6 (32.3)	21	4,435 (2,015)	3,000 at 16" O.C. (1,360 at 406mm O.C.)
ResinDek® Xspan® FR MetaGard® B Deck Not Required	6.6 (32.3)	21	4,435 (2,015)	3,000 at 16" O.C. (1,360 at 406mm O.C.)

We recommend wearing gloves when handling ResinDek panels with MetaGard and proper PPE (Personal Protective Equipment) when cutting and installing panels with MetaGard.

PLEASE NOTE: THE INSTALLATION OF RESINDEK WITH METAGARD IS THE SAME AS PAGE 4 WITH THE FOLLOWING EXCEPTIONS:

- For flatness requirements on Robotic floors, please refer to robotic manufacturers specification. If none are provided, please default to +/- 1/8" (3mm) over 36" (914mm).
- ResinDek panels with the MetaGard steel surface should be installed with a 1/16" (1.6mm) minimum gap. Additionally, anywhere a ResinDek panel with MetaGard adjoins a non MetaGard panel, a 1/16" (1.6mm) gap should also be used. The maximum gap should be 3/16" (4.8mm).
- Be sure to trim the last row of panels to allow for a 1/4" (6mm) to 1/2" (12mm) gap along the outer edges of the ResinDek MetaGard floor perimeter. You can trim ResinDek MetaGard panels to size with a circular saw. For best results use a 3000-4000 RPM saw with high speed steel blades or carbide tip blades that are 7-1/4" (178mm) diameter with 24 - 40 teeth. **FOR SAFETY REASONS DEBURR THE CUT EDGE WITH A GRINDER OR FILE.**
- Before securing ResinDek MetaGard panels to the corrugated metal deck, it is necessary to countersink the screws using a countersink bit (**Figure A**). Countersink bits are available to purchase through Cornerstone Specialty Wood Products. A 2500 – 3000 RPM drill is recommended for the countersinking process. For more information please contact Cornerstone Specialty Wood Products at 513.772.5560.
- Drive screws so that the top is just below the ResinDek MetaGard panel surface (**Figure B**). Proper screw head depth is critical to performance and appearance of your ResinDek MetaGard floor.

Figure A.
Countersink Bit
Part No. COR9081



Figure B.

